

PRECISION BALANCES PS 3Y



release date 29-01-2015













Additionally option: PS xx.3Y.B

Balances PS 3Y series are laboratory weighing instruments featuring 5,7" LCD colour touch panel which provides new possibilities of balance operation and presenting measurement results.

Personalization of balance settings is carried out in extended user profiles. 3Y series comes standard with system of automatic internal adjustment.

Level control is based on LevelSENSING system, RADWAG patented solution, which uses a system of an electronic level. New function of PS 3Y series is online monitoring of ambient conditions through built-in sensors or an external ambient conditions module THB 2 series.

PS 3Y series offers two models of weighing pans which enable weighing with different accuracy. New working mode of the PS 3Y series: differential weighing, allows the balance to control mass of the same sample subjected to differed processes over time. Extended databases enable storing all carried out measurements, with option of printing and exporting them. Standard and user defined printouts allow for maintaining documentation complying with GLP/GMP requirements practically in any application. PS 3Y series features an independent mass control mode carried out with application of an automatic feeder PA-02/H.

-  Weighing
-  Parts counting
-  Checkweighing
-  Dosing
-  Percent setup
-  Density determination
-  Animal weighing
-  Formulation
-  Statistics
-  Differential weighing
-  Mass control

NOVELTY:

3Y series balances are equipped with **802.11b/g/n WiFi** communication interface operating with frequency range 2.4÷ 2.472 GHz (1÷13 channels). Communication is established likewise as for any other interfaces, e.g.: RS 232, Ethernet.

Technical data:

	PS 200/2000.3Y	PS 250.3Y	PS 450.3Y	PS 600.3Y	PS 750.3Y	PS 1000.3Y	PS 1500.3Y	PS 2500.3Y	PS 4500.3Y	PS 6000.3Y
	M	M	M	M	M	M	M	M	M	M
Max capacity	200/2000 g	250 g	450 g	600 g	750 g	1000 g	1500 g	2500 g	4500 g	6000 g
Minimal load	20 mg	20 mg	20 mg	20 mg	20 mg	20 mg	500 mg	500 mg	500 mg	500 mg
Readability	1/10 mg	1 mg	1 mg	1 mg	1 mg	1 mg	10 mg	10 mg	10 mg	10 mg
Tare range	-200/-2000 g	-250 g	-450 g	-600 g	-750 g	-1010 g	-1500 g	-2500 g	-4500 g	-6000 g
Linearity	±2/10 mg	±2 mg	±2 mg	±3 mg	±3 mg	±3 mg	±20 mg	±20 mg	±20 mg	±30 mg
Repeatability	1/10 mg	1 mg	1 mg	1,5 mg	1,5 mg	1,5 mg	10 mg	10 mg	10 mg	15 mg
Pan size	128×128 mm						195×195 mm			
Stabilization time	2 s / 1,5 s	2 s	2 s	2 s	2 s	2 s	1,5 s	1,5 s	1,5 s	1,5 s
Sensitivity drift	2 ppm/°C in temperature +15 ÷ +35 °C									
Working temperature	+10 ÷ +40 °C (**)									
Power supply	13,5 ÷ 16 V DC / 2,1 A									
Interface	2×USB, 2×RS 232, 1×Ethernet, Wi-Fi 802.11 b/g/n, 4 inputs / 4 outputs (digital)									
Packaging size	716 × 360 × 260 mm									
Display	5,7" touch panel									

** Balance maintains parameters in accordance with type approval in temperatures 15 ÷ 35°C;

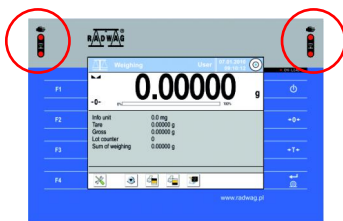

Infrared proximity sensors

- PRINT function
- TARE function
- opening weighing chambers
- sensors' sensitivity



Data exchange through USB storage devices

- export weighing data
- export/import databases
- export/import balance settings
- exchanging data between balances



Communication interfaces

- Ethernet 10/100 Mbps
- Wi-Fi 802.11 b,g,n,
- RS 232
- 2×USB 2.0
- 4 in/out

Dimensions:

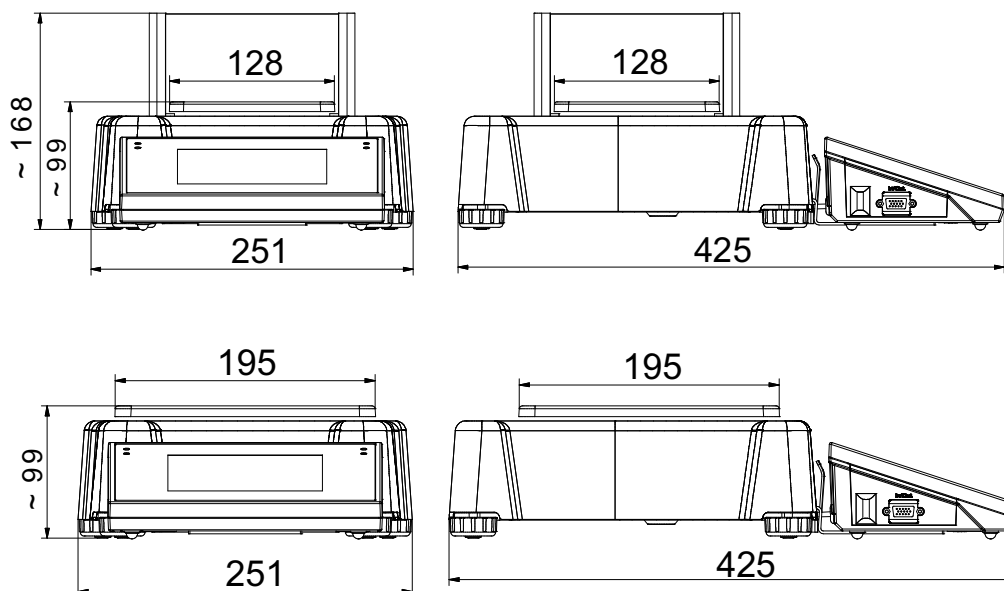

Additional equipment:

Anti vibration table for laboratory balances	Automatic feeder PA-02/H
Printer Epson, Citizen	Mass standard
Foot button for tare or print functions	LCD display WD-5
Density determination kit for solids and liquids	Power adapter with battery and charger ZR-02
PC USB keyboard	Power loop output AP2-1 (plastic version)
Anti draft shield	Antistatic cable PA 1
Bar code scanner	Computer software: PW-WIN, RAD-KEY
THB 2 ambient conditions module	Cable: P0136, P0151